

OCTA WALL 60

HYBRID

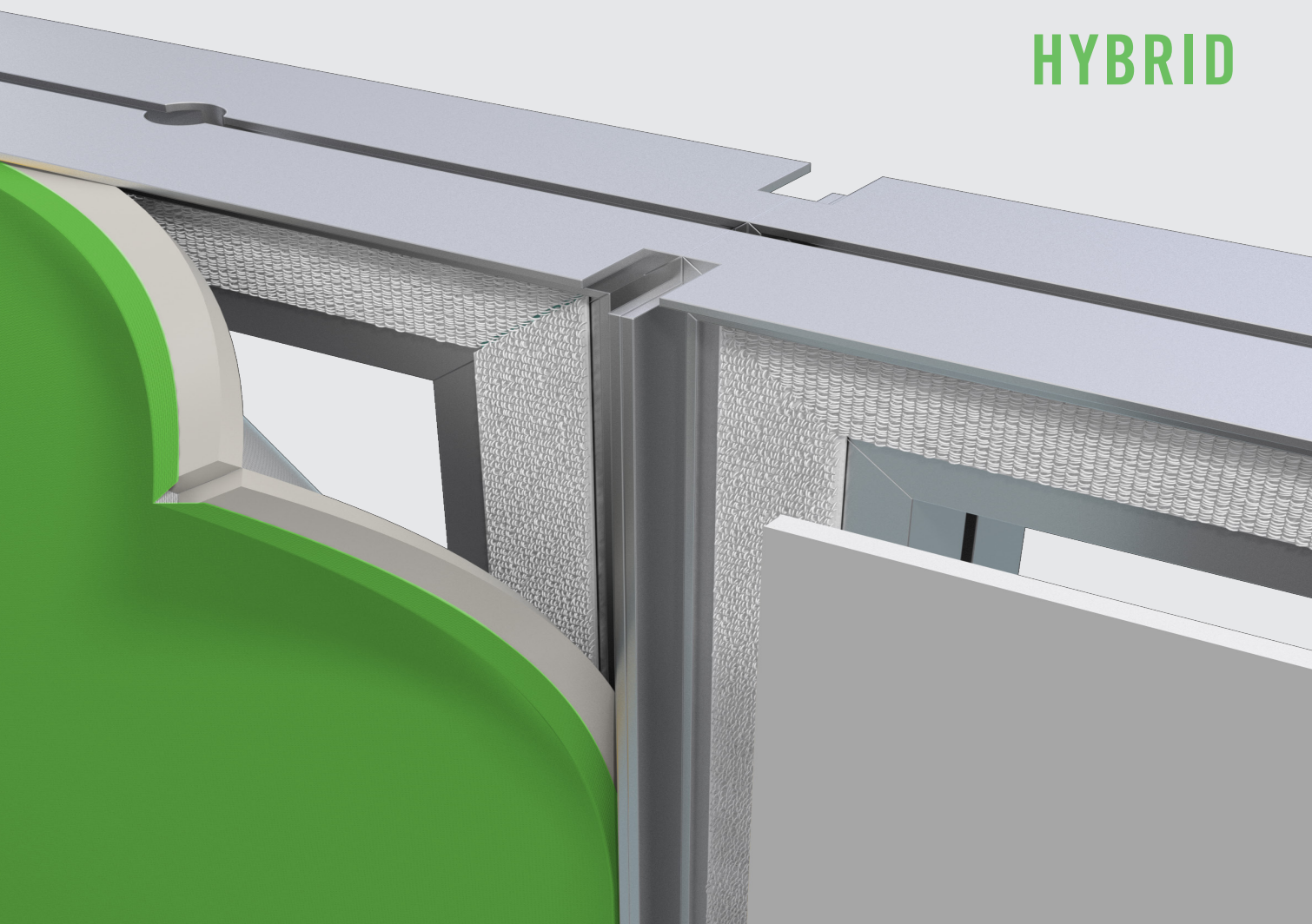

OCTAWALL 60

HYBRID

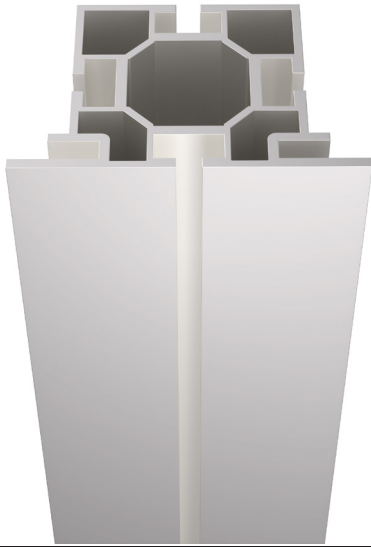

**ONE SOLUTION.
FOR FABRIC AND PANELS.
THE ALL-ROUNDER W 735R.**

EXAMPLE FITTING:

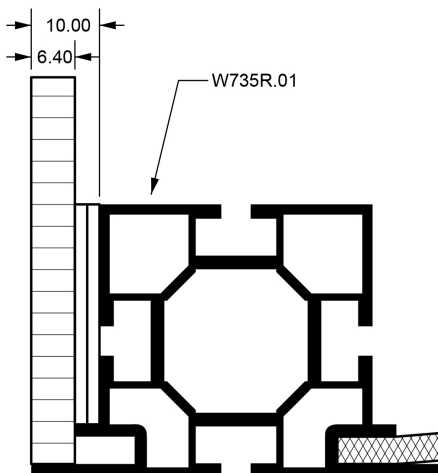

DIMENSIONS IN MM:

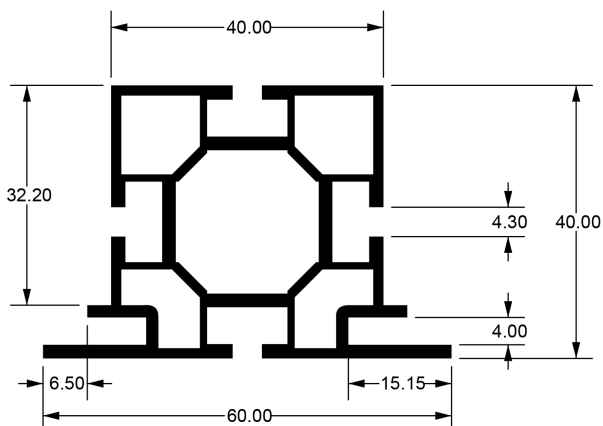

Because it's your decision if you want fabric or panels.

OCTAWall 60 Hybrid means more flexibility: both sides offer the possibility of using fabric or panels. This doesn't just make OCTAWall 60 incredibly flexible, it also makes storage and transportation easier because all you need is one extrusion!

Today fabric - tomorrow panel.

The high quality hook and loop tape proves itself through the safe and tool-less installation of panels. The well-proven system groove and silicone edge system adds tension to your fabric. Together, they offer a modern surface look and utmost flexibility.

Technical details:

- one frame element for installation of fabric and panel
- panel: 6 mm rigid panel
- fabric: fabric with silicone edges on all sides
- hook tape installed on request, loop tape sold separately
- the same frame connection as with OCTAWall 40 and 60 (M 1477 and M 1496/USA respectively)
- internal corner connector Z 990.00
- all existing OCTAWall accessories (such as base plates, LED spotlights, ...) can be used with OCTAWall 60 Hybrid

TECHNICAL FEATURES

OCTAwall 60 Hybrid

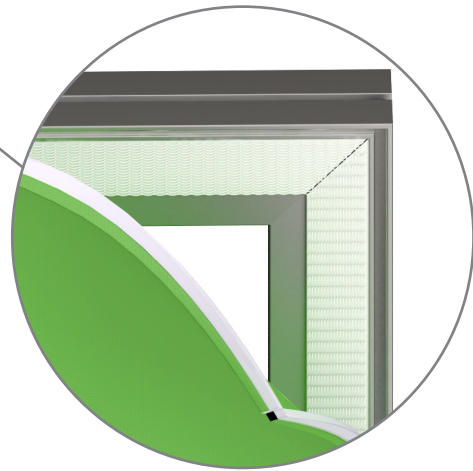

CONVENIENT.
SYSTEM GROOVE FOR FABRIC.
HOOK TAPE FOR PANELS.



OCTAWALL 60

HYBRID

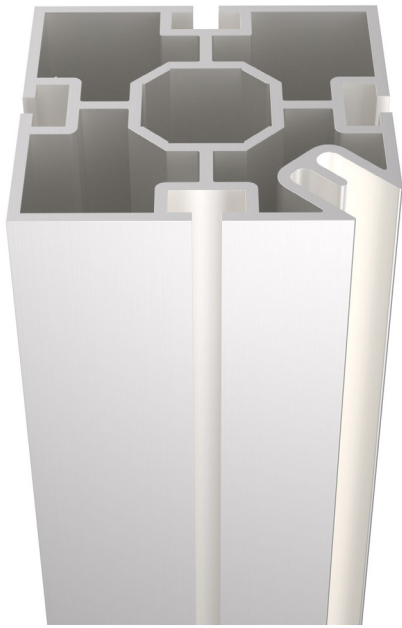

SEAMLESS FABRIC CORNER.
NO COMPROMISE.
THE S385R CORNER PROFILE.

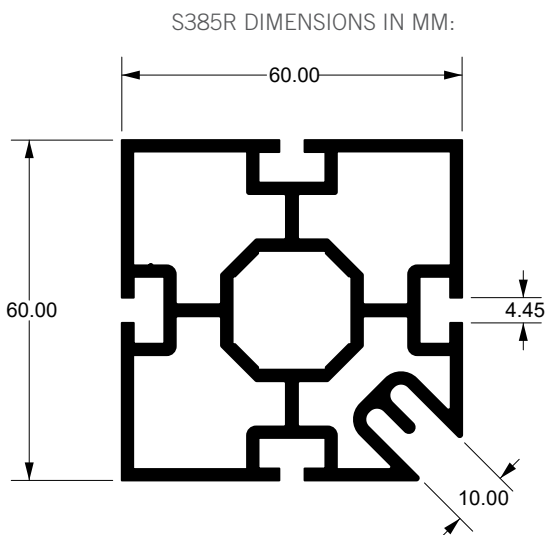

Flexible. Without interruption.

Thanks to the new S385R corner profile, there will be no visible corner upright anymore. The straight corner and minimalistic design allow for around-the-corner graphics, offering maximum advertisement space.

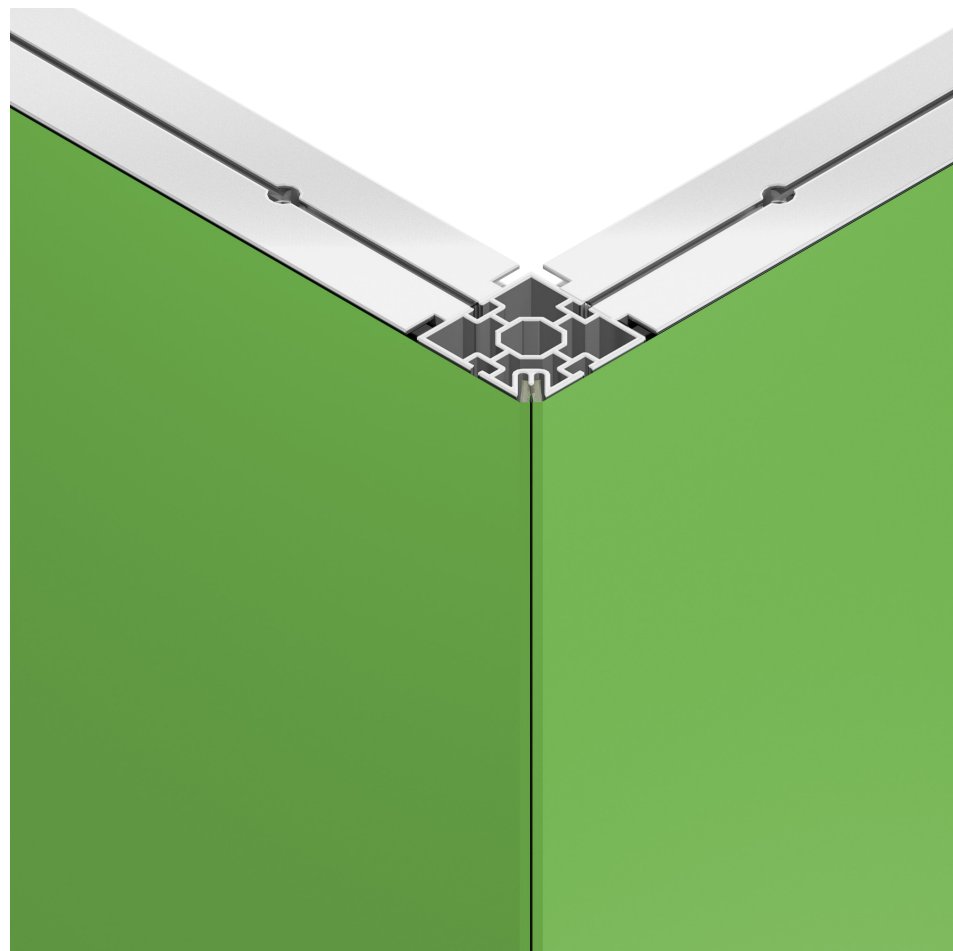

PARTS

OCTAwall 60 Hybrid

FRAME ELEMENT FOR FABRIC + PANEL



Aluminium | 1 x frame,
for installation between 2 frames
or 2 extrusions, incl. 2 x C 440/F
adjustable foot with drillings for
OL 200.21/H baseplate

Millings for cable management
included

W 770.01/USA
STRAIGHT, 990 MM

frame size:
W 990 x H 2444 mm

SEG fabric visual graphic
area: 986 x 2440 mm
Panel Size: 985 x 2439
mm

W 771.01/USA
STRAIGHT, 960 MM

frame size:
W 960 x H 2444 mm

SEG fabric visual graphic
area: 956 x 2440 mm
Panel Size: 955 x 2439
mm

W 772.01/USA
STRAIGHT, 930 MM

frame size:
W 930 x H 2444 mm

SEG fabric visual graphic
area: 926 x 2440 mm
Panel Size: 925 x 2439
mm

W 777.01/USA
STRAIGHT, 495 MM

frame size:
W 495 x H 2444 mm

SEG fabric visual graphic
area: 491 x 2440 mm
Panel Size: 490 x 2439
mm

W 778.01/USA
STRAIGHT, 465 MM

frame size:
W 465 x H 2444 mm

SEG fabric visual graphic
area: 461 x 2440 mm
Panel Size: 460 x 2439
mm

W 779.01/USA
STRAIGHT, 435 MM

frame size:
W 435 x H 2444 mm

SEG fabric visual graphic
area: 431 x 2440 mm
Panel Size: 430 x 2439
mm

W 773.01/USA
STRAIGHT, 990 MM

frame size:
W 990 x H 1222 mm

SEG fabric visual graphic
area: 986 x 1218 mm
Panel Size: 985 x 1217
mm

W 743.01/USA
CURVED, HYBRID FRAME

curved,
525 mm radius 90 degree curved frame
R 525 x H 2444 mm

FRAME PROFILE FABRIC + PANEL

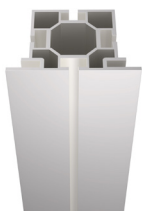

W 735R.01

Aluminium | can be fitted with
fabric (in combination with silicone
edge M 1313) or panels
6.35 kg | 6000 mm

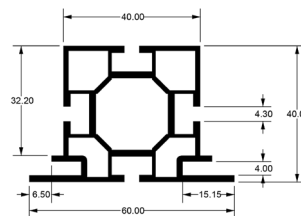

T-PROFILE
PANEL, FOR 90° ANGLE



Also available in different lengths

W 783.01/USA

Aluminium I for panels,
2 x Z 961/8 tension locks
2.44 kg l 2364 mm

W 783.01B/USA (CUSTOM)

2 x Z 961/8 tension locks
2920 mm (max)

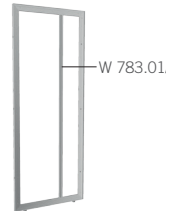

T-PROFILE
FABRIC, FOR 90° ANGLE



Also available in different lengths

W 781.01/USA

Aluminium I for fabric,
2 x Z 961/8 tension locks
2.39 kg l short dim: 2364 mm
long dim: 2428 mm

W 781.01B/USA (CUSTOM)

Custom for panels up to 3000 mm
short dim: 2920 mm (max)
long dim: 2984 mm (max)

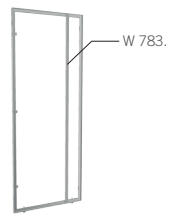

DOOR ELEMENT
DIN RIGHT



Attention: On lock side, W 799.01/USA extrusion or W 886.01/USA upright must be installed

W 795.01/USA

Aluminium I 1 x door DIN right,
incl. 1 x threshold band,

SEG fabric visual graphic area:
971 x 2020 mm

Panel Size: 970 x 2019 mm

10.00 kg

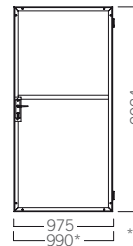

* installation dimension

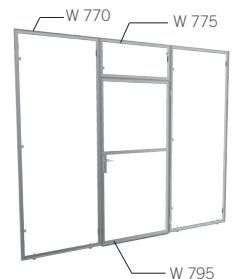

DOOR ELEMENT
DIN LEFT



Attention: On lock side, W 799.01/USA extrusion or W 886.01/USA upright must be installed

W 797.01/USA

Aluminium I 1 x door DIN left,
incl. 1 x threshold band,

SEG fabric visual graphic area:
971 x 2020 mm

Panel Size: 970 x 2019 mm

10.00 kg

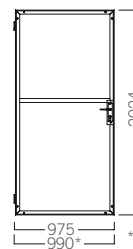

* installation dimension

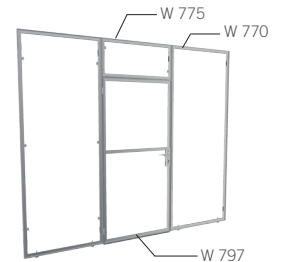

FRAME ELEMENT
MOUNTED ABOVE DOOR, 990 MM



W 775.01/USA

Aluminium I 1 x frame, for
mounting above door W 795 and
W 797

SEG fabric visual graphic
area: 986 x 410 mm

Panel Size: 985 x 409 mm 3.43 kg

10.00 kg

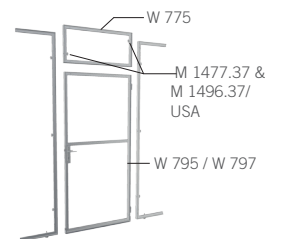
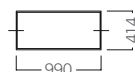

PARTS

OCTAwall 60 Hybrid

FRAME ELEMENT REPLACEMENT VERTICAL



W 799.01/USA

Aluminium | replacement vertical for standard milled panels with slots for door latch and lock 2444 mm

W 799.01B/USA

Custom length up to 3000 mm (max)

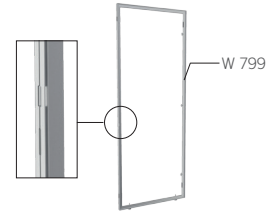
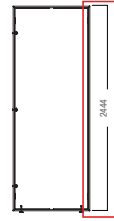

EXTRUSION FOR DOOR MOUNTING



W 886.01/USA

Aluminium | M 1010.01 post milled with slots for door latch and lock 2444 mm

W 886.01B/USA

Custom length up to 3000 mm (max)

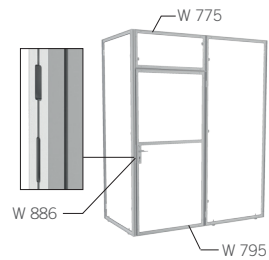

EXTRUSION FOR CORNER, WITH ADJUSTABLE FOOT



W 822.01

Aluminium | to fix fabric panels on one or both sides in connection with SEG M 1313 tension lock Z 961/8 can be mounted
Note: cut out on both ends required when cut to size
3.2 kg | 5000 mm

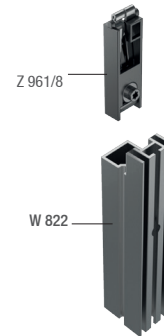
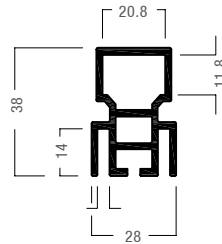

EXTRUSION FOR FRAME TO FRAME CONNECTION, PANEL



W 827.01

Aluminium | tension lock Z 961/8 can be mounted
4.7 kg | 5000 mm

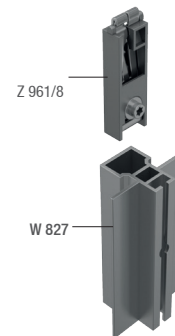
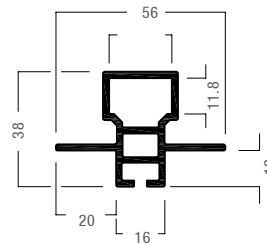

END CAP FOR PROFILE S 385

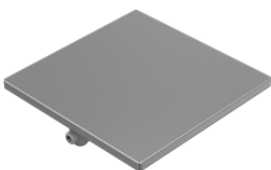

S 405.37

to mount on S 385R profile, to ensure the SEG stays in groove
incl. 1 set screw M 1075/20 (M4)

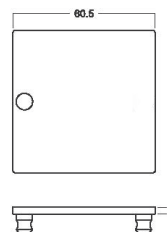

CORNER EXTRUSION



S 385R.01

Aluminium | for connection of OCTAwall 60 fabric over frame fabric- can be mounted over the profile onto the edge 5000 mm

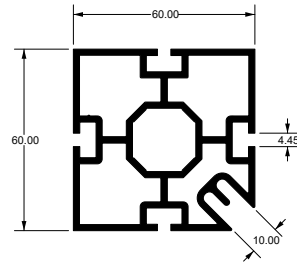

TRIANGULAR PROFILE



M 1170.01

Aluminium
4.85 kg | 6000 mm

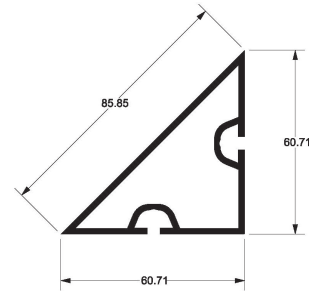

CLADDING PROFILE FOR LATERAL FRAME END



W 810.01

Aluminium | for frame elements, to clad the lateral frame edges, incl. 10 × E 470/C plastic clips (Recommendation: 2 pcs./m), 1.35 kg | 5000 mm

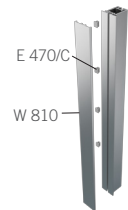

BASE PLATE 600 × 100 MM



OL 200.21/H

Steel | for free-standing frame elements, includes thru-bolting hardware for W 735R.01 powdercoated RAL 9006



FOOT ADJUSTABLE



S 395.37

Steel | incl. 1 set screws M 1075/20 (M4) for S385R.01 extrusion

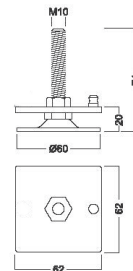

PARTS

OCTAwall 60 Hybrid

T-POST



W 823.01

Aluminium | SEG corner T-Post
60 mm, 5.47 kg | 2444 mm

W 823.01B

Custom up to 3000 mm (max)

W 823X.01

Extension post for use with
W823.01 | 2444 mm

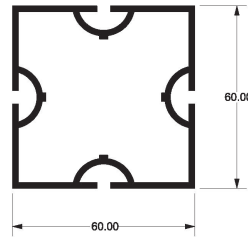

! Millings for cable management included on all posts below.

TRIANGULAR CORNER

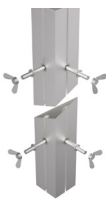

W 824.01

Aluminium | SEG corner post
60 mm, 4.49 kg | 2444 mm

W 824.01B

Custom up to 3000 mm (max)

W 824X.01

Extension post for use with
W824.01 | 2444 mm

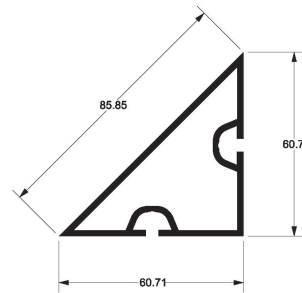

SEG CORNER



S 415.01

Aluminium | SEG corner post
60 mm, 7.81 kg | 2444 mm

S 415.01B

Custom up to 3000 mm (max)

S 415X.01

Extension post for use with
S415.01 | 2444 mm

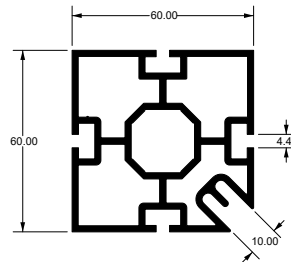

4-WAY POST



W 826.01

Aluminium | 4-way post
60 mm, 5.53 kg | 2444 mm

W 826.01B

Custom up to 3000 mm (max)

W 826X.01

Extension post for use with
W826.01 | 2444 mm

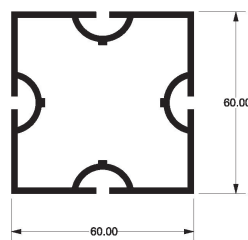

CORNER CONNECTOR FOR FRAME ELEMENTS



Z 990.00

Zinc die-cast | incl. 2 M 10 threads
for C 440/F adjustable foot
incl. 2 x E 111 and E 111/20 hex-
star screws
for profiles with 21 x 12 mm lock
chamber
0.22 kg

Marginal distance for foot
C 440/F = 100 mm

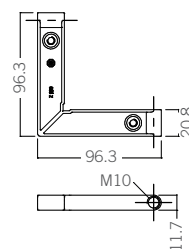

**MOUNTING SET
FOR FRAME CONNECTION**



M 1496.37/USA

Steel I for frames W 770 - W799
used to bolt thru two frames
0.08 kg

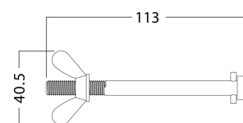

**MOUNTING SET
FOR FRAME CONNECTION**



M 1477.37

Steel I to connect through frames
into system groove
0.04 kg

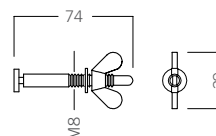

**ADJUSTABLE FOOT
M 10, FOR FRAME ELEMENTS**

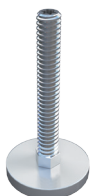

C 440/F.37

Steel I for installation in frame
elements in connection with Z 990
internal corner connector
0.07 kg

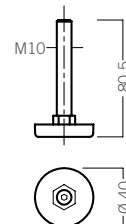

SPACER

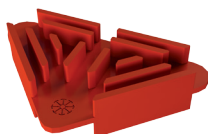

W 1000.90

Plastic, red I to secure frames in
place for safe packaging, storage,
and transportation. Suitable for all
OCTAwall frame systems.
0.01 kg

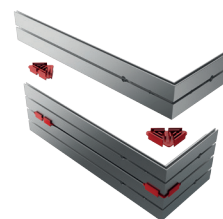
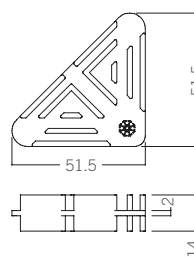

LED ARM LIGHT



VA 5021.90

Aluminium / die-cast, silver-grey I
incl. 1 x VA 0051, 1 x cable
110 V
0.61 kg

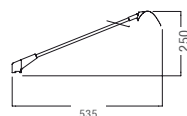

PARTS

OCTAwall 60 Hybrid

HOOK AND LOOP TAPE FOR FRAME ELEMENT



NP 1010.30

Polyamide, white | adhesive,
width 20 mm, thickness ca. 2 mm,
HOOK tape

NP 1011.30

Polyamide, white | adhesive,
width 20 mm, thickness ca. 2 mm,
LOOP tape

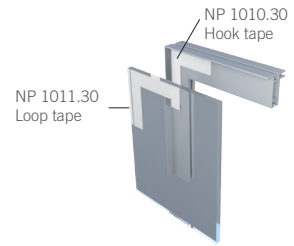

HOOK TAPE INSTALLED ON FRAME



VC 1910A.30

Polyamide, white | adhesive,
velcro installed on ONE SIDE of
frame only. 1 inch

VC 1910B.30

Polyamide, white | adhesive,
velcro installed on BOTH SIDES of
frame. 1 inch

SCREWDRIVER HEX-STAR T 30



M 951.90

Plastic / Steel | T 30 hex-star
0.07 kg

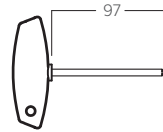

SILICONE EDGE



M 1313.50

Silicone | for fixing of graphics for
all fabric tension extrusions 100
meter roll
5.31 kg | 11.706 lbs

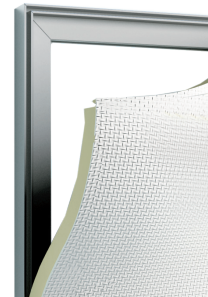

PLACING OF HOOK TAPE NP1010.30 TO FRAME

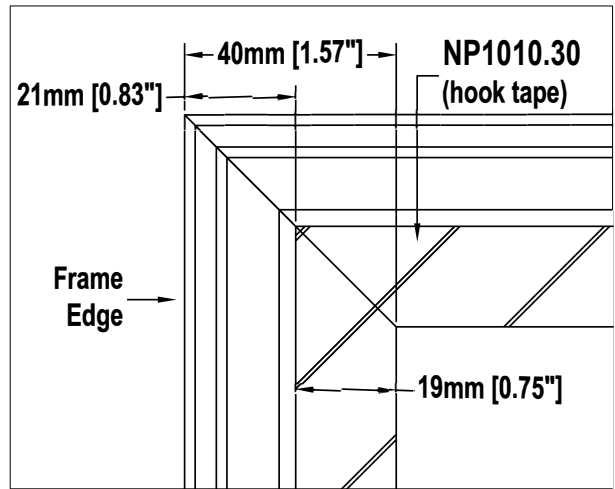
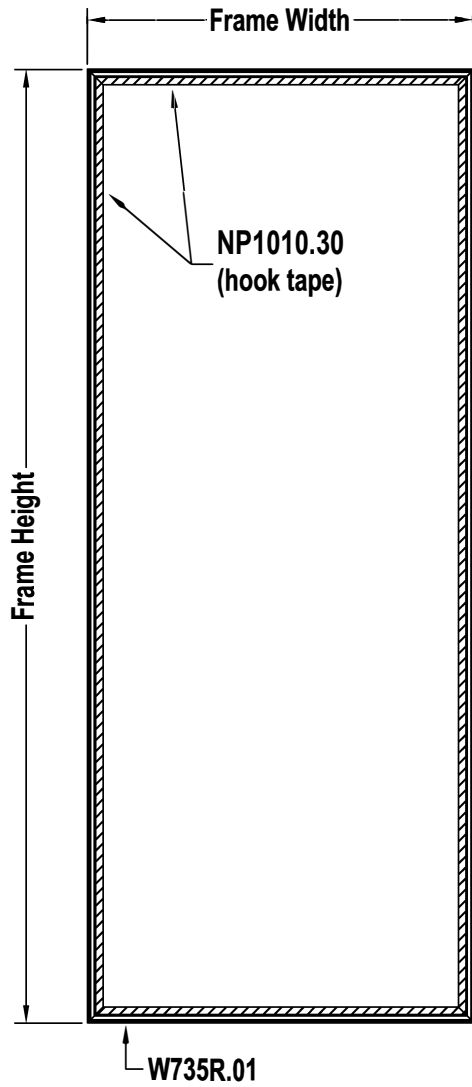

POSITION OF CABLE CUT OUT (ON REQUEST)

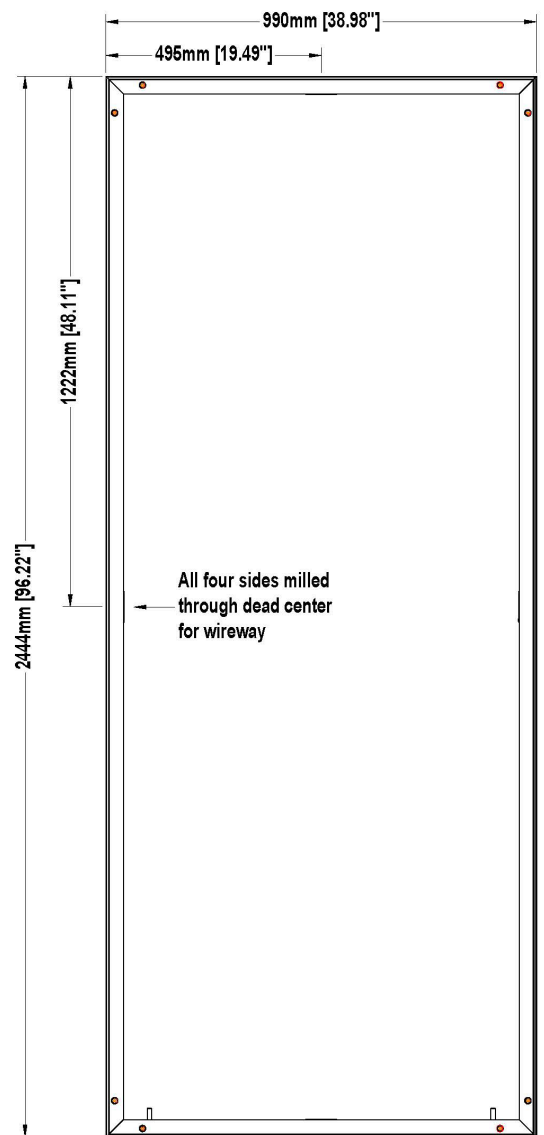

TECHNICAL INFORMATION

OCTAwall 60 Hybrid

CUTTING DIMENSIONS

Cutting dimensions door panel :

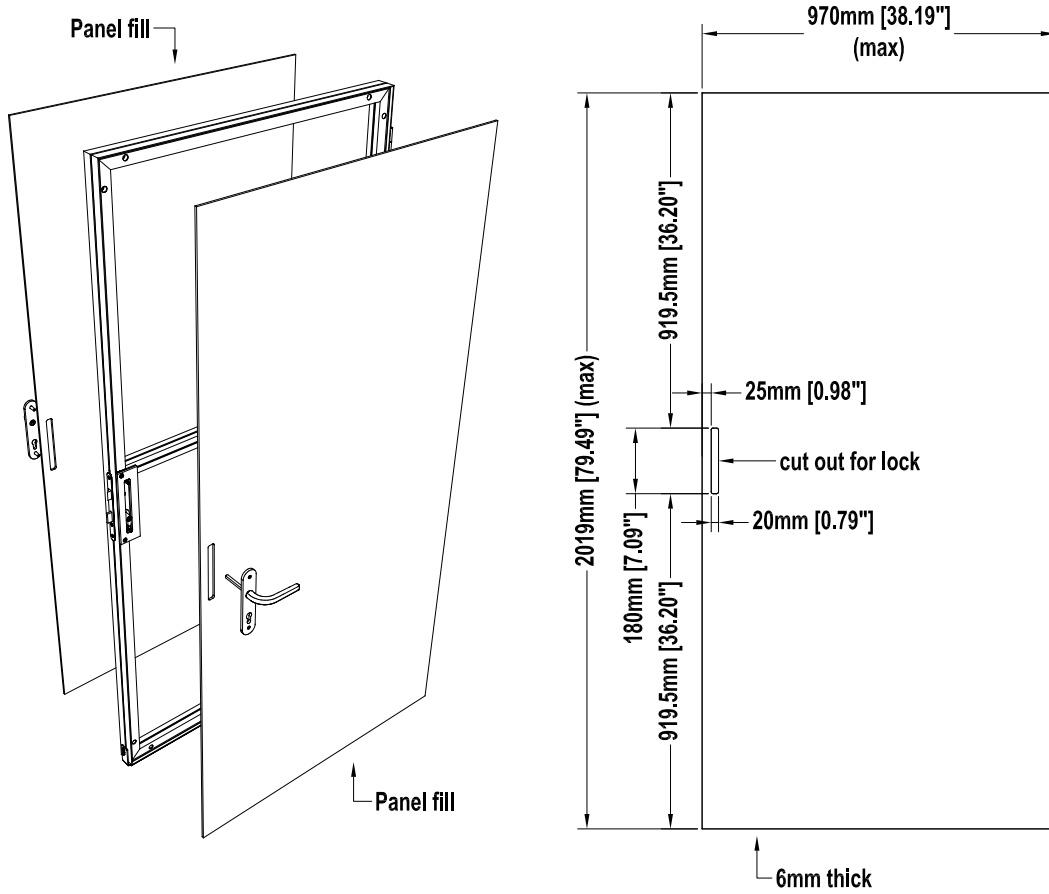

Cutting dimensions wall panel:

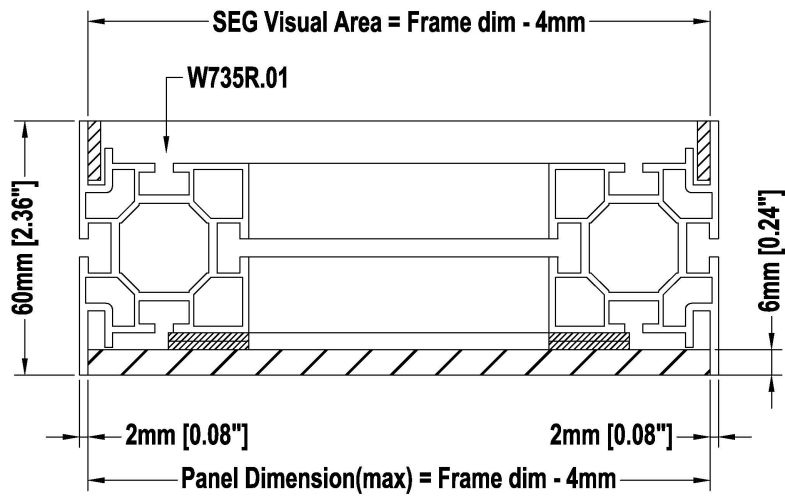

EXHIBITION SYSTEMS
PROJECT SOLUTIONS
PRESENTATION
INTERIOR DESIGN
CLEANROOM SYSTEMS

OCTANORM® Germany

Head Office

Raiffeisenstraße 39
70794 Filderstadt
T. +49 711 77003-0
F. +49 711 77003-53
info@octanorm.de
www.octanorm.com

EUROPE

OCTANORM® Belgium

T. +32 2 344 9880
www.octanorm.be

OCTANORM® France

T. +33 1 4695 5406
www.octanorm.fr

OCTANORM® UK

T. +44 20 85 45 2945
www.octanorm.co.uk

OCTANORM® Hellas

T. +30 2310 79 6521
www.octanorm.gr

OCTANORM® Italia

T. +39 02 9645 1966
www.formulaotto.it

OCTANORM® Nederland

T. +31 50 309 5133
www.octanorm.nl

OCTANORM® Polska

T. +48 22 773 0350
www.octanorm.pl

OCTANORM® Adria

T. +386 590 56301
www.octanormadria.com

OCTANORM® Espana

T. +34 930 019 424
www.octanorm.es

OCTANORM® Nordic

T. +46 8 621 6500
www.octanorm.se

OCTANORM® Russia

T. +7 495 565 7920
www.octanorm.ru

AMERICA

OCTANORM® North America

T. +1 770 732 1520
www.octanormna.com

OCTANORM® México

T. +52 55 5804 6325
www.octanorm.com.mx

OCTANORM® Brasil

T. +55 11 3807 2552
www.octanorm.com.br

OCTANORM® Argentina

T. +54 11 43 12 4000
www.octanorm.com.ar

AFRICA

OCTANORM® South Africa

T. +27 11 433 2010
www.octanorm.co.za

MIDDLE EAST

OCTANORM® Emirates

T. +971 4 340 6888
www.octanormemirates.net

AUSTRALIA

OCTANORM® Australia

T. +61 3 8773 8550
www.octanorm.com.au

ASIA

OCTANORM® Japan

T. +81 45 511 8144
www.octanorm.jp

OCTANORM® China

T. +86 512 6283 3336
www.octanorm.cn